



Your Reliable Power Partner



医疗电源供应器

AC/DC 开关电源 & DC/DC 转换器



公司简介

明纬 (MEAN WELL) 成立于1982年,为世界标准交换式电源供应器领导品牌制造商之一,目前在全球共设有五座生产基地(台湾地区新北市、中国大陆广州市、中国大陆苏州市、印度邦加罗尔以及美国堪萨斯城),全球总部位于台湾地区新北产业园区,在中国广州/深圳/苏州/香港、美国加州、欧洲荷兰、亚洲土耳其、新加坡、马来西亚和印度设有分公司及办事处。明纬产品包含:AC/DC交换式电源、DC/DC转换器(Converter)、LED防水电源、适配器(Adapter)、电池充电器(Charger)以及DC/AC逆变器(Inverter)等产品。目前已超过10,000种标准电源机型,广泛应用于医疗、工业自动化、电子、通讯、LED照明等产业。

明纬医疗电源全产品超过80多个系列和500个型号供客户选择,覆盖1~1200W,提供3~55V单/多输出电压。我们致力于发展绿色医疗电源,并符合国际能效等级Level VI。

为了符合严苛的医疗设备安全法规,明纬医疗电源不仅通过 IEC60601-1第三版法规,而且具有2xMOPP/MOOP等级,对病患及医护人员提供了最高层次的安全防护。

欧洲明纬



苏州明纬



台湾明纬



印度明纬



新加坡明纬



马来西亚明纬



整系列产品符合国际法规UL/CUL/TUV/EAC/CB/CE/FCC及电磁兼容 (EMC)测试从而进一步保证安全使用,适用于家用医疗设备和各种适合在医院使用的医疗设备。

明纬具备近40年的标准电源产品研发及制造经验,公司拥有12大产品线,超过10000余种标准电源产品,提供客户[一站式购足]的电源解决方案。每一款产品从技术研发、设计、试做、设计验证(DVT)、设计品质测试(DQT)、选料、试产、量产等,均透过严谨的设计与生产及品质管控程序与测试验证规范标准。

产品透过全球80余个国家和地区、超过200家备库存之经销商,样品于24小时内即可迅速提供,且没有最小订购量限制。若您正在寻找高信赖度、品质稳定、价格合理、产品系列齐全的标准电源供应商,拥有最完整解决方案的明纬公司,绝对是您的首选。

美国明纬



广州明纬

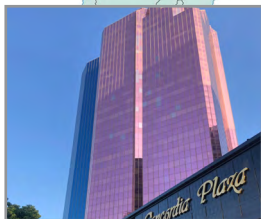

香港明纬



信赖的品质

[MEAN WELL]的品牌意涵为[善意的标志, 品质的执着]。我们了解品质是专业电源制造厂的命脉, 成为[客户信赖的电源伙伴]是明纬持续成长的动力。

明纬于1994年即领先同行业通过ISO9001质量管理体系认证, 开始推行全面品质管理(TQM)系统, 每年皆经TUV稽核来不断检讨与改善, 向建构完善的品质体系而努力。2013年取得环境管理体系, 2015年取得职业健康安全管理体系, 将环保理念化为实际行动, 期望创造安全健康的环境。



ISO45001



ISO9001



ISO14000

明纬医疗电源产品符合 UL/CUL/TUV/CB/EAC/CE/FCC 等国际认证, 其中包含 ANSI/AAMI ES60601-1/ ES60601-1-11, TUV EN60601-1/ EN60601-1-11, TPTC004, IEC60601-1, EN55011, EN55032.

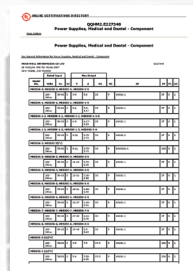
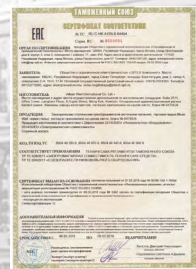



明纬拥有一套完善的品质管理体系。制程上采用100%烧机、功能测试及耐压测试，并搭配使用MIL-105E抽样方法于IQC、PCBQC(半成品检验)、FQC等阶段，以确保产品品质。在研发阶段，品质工程师针对每样产品量身拟定测试计划(Test Plan)，于试产前完成DFMEA、DVT、DQT、ORT、EMC、跌落测试、振动测试、冷热冲击测试、可靠性测试等验证。

在制造阶段，则由产品工程师协同制程/生技工程师进行产品试作/试产审查、半成品品质管制、制程查核、成品品质管制，生产品质问题反馈分析与改善等。

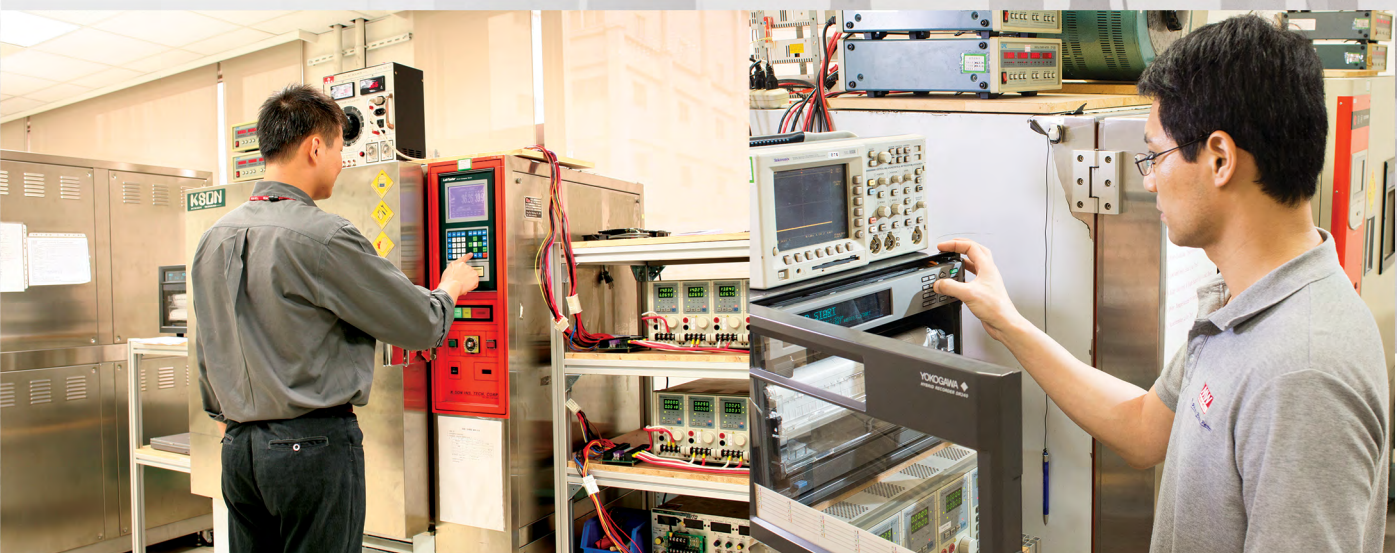

产品范围

AC/DC 基板型

- 30~500W
- 1~4 输出
- 3.3~48V
- MOPPx2 & BF 等级
- 完整尺寸范围

系列	页码
RPS, RPD, RPT, MPQ	13-16



AC/DC 外置适配器

- 6~220W
- 5~48V
- Level VI
- 多种外型可选
- MOPPx2 & BF 等级

系列	页码
GSM, GEM	7-12

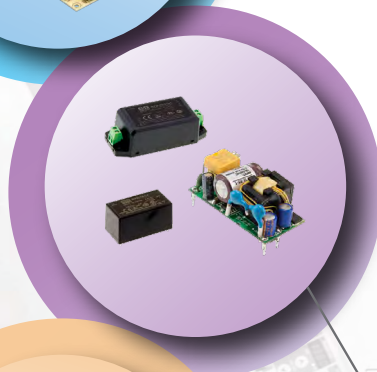

AC/DC 板上型

- 5~90W
- 3.3~48V
- PCB 安装
- 小体积
- MOPPx2 & BF 等级
- 工作温度: -40~+85°C

系列	页码
MPM, MFM	17-20

AC/DC 机壳型

- 100~1200W
- 工作温度: -40~+70°C
- 3~55V
- 1U 低高度
- 5 年保固期

系列	页码
NMP, RPS-C, MSP	21-24

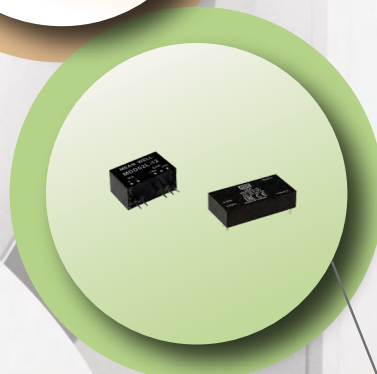

DC/DC 转换器

- 1~20W
- $\pm 10\%$ & 2:1 V_{in}
- SIP7 & 2"x1" 封装
- 单组 & 双组输出
- 低漏电流 $< 2\sim 5\mu A$
- 输入/输出隔离: 6KVdc

系列	页码
MDS, MDD	25-27



超声波扫描仪



手术室

如何分辨 MOPP 与 MOOP 在 IEC 60601-13rd 的不同

自2005年国际电工委员会 (IEC) 发布了医疗安全标准第三版 (IEC60601-1:2005), 取代原有第二版 (IEC60601:1998)。第二版和第三版之间主要差别是绝缘等级, 第二版分为 BI (Basic Isolation), SI (Supplementary Isolation), DI (Double Isolation) 和 RI (Reinforced Isolation), 新 IEC60601-1 第三版则区分为 MOPP 和 MOOP 两种类别。

第三版本最主要的影响是把使用者区别为“一般操作人员”与“病患”, 因此 Means of Protection (MOP) 的概念被引进到第三版中。MOP 进一步被区分成两种不同类别, 即病患保护方式 Means of Patient Protection (MOPP) 及操作者保护方式 Means of Operator Protection (MOOP)。

医疗产品制造商有责任确定病患接触的可能性, 以决定是使用 MOPP 或是 MOOP, 如果医疗设备会接触病患就必需符合 MOPP 绝缘等级。

无论哪种, 在正常情况下, PRIMARY 到 SECONDARY 之间的绝缘必须满足至少 $2 \times MOP$, PRIMARY 到保护性接地 (FG) 之间必须满足至少 $1 \times MOP$ 。如图1所示。

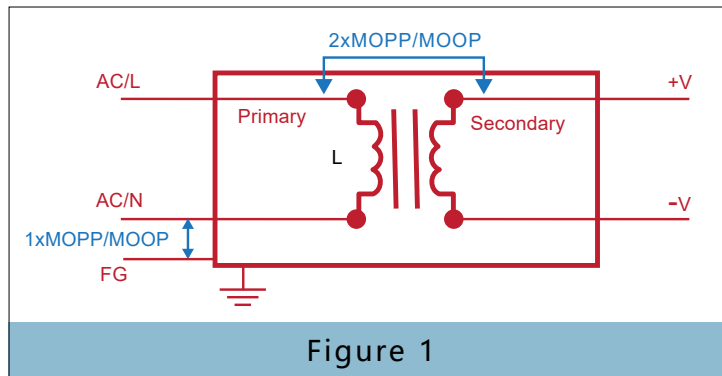

满足 $2 \times MOPP$ 标准的电源可以提供最高级别的保护。所以使用 $2 \times MOPP$ 电源非常有利, 因为它可以覆盖大部分的医疗应用。



医疗床



救护车



AC/DC 适配器

6~220W

特性

- 多种外型可选:
桌上型、插墙式、输入插头可换
- 输出电压从 5V~ 48V可选
- Class I & II 机型可选
- ANSI/AAMI ES60601-1-11, EN60601-1-11
家居医疗法规
- 通过医疗类安规认证 (2xMOPP)
- 适用于BF等级应用需求
(除 GSM40A~220A系列)
- 多种DC插头供选择
- 低漏电压<50~100 μ A
- 空载损耗<0.075~0.15W
- 能效等级 Level VI
(6W 和 18~60W 5~9V 为 Level V)
- 工作温度可高达 70 $^{\circ}$ C
- 其它DC插头可选
- 符合 EISA 2007/DoE, NRCan,
AU/NZ MEPS, EU ErP 并满足 CoC version 5
- 3 年保固





▲ GEM06I/12I
73.9x 39x 48.5mm



USB 型



▲ GEM18I/30I/40I/60I
75.5x 39.1x 56.2mm

■ 插墙式(可更换插头型/Class II) — 6W

型号 (主体)	输出	效率
GEM06I05-USB	5V, 1.20A	70%
GEM06I05-P1J	5V, 1.20A	70%
GEM06I06-P1J	6V, 1.00A	74%
GEM06I07-P1J	7.5V, 0.80A	74%
GEM06I09-P1J	9V, 0.66A	76%
GEM06I12-P1J	12V, 0.50A	76%
GEM06I15-P1J	15V, 0.40A	79%
GEM06I18-P1J	18V, 0.33A	79%
GEM06I24-P1J	24V, 0.25A	80%

■ 插墙式(可更换插头型/Class II) — 12W

型号 (主体)	输出	效率
GEM12I05-USB	5V, 2.40A	80%
GEM12I05-P1J	5V, 2.40A	80%
GEM12I07-P1J	7.5V, 1.60A	82%
GEM12I09-P1J	9V, 1.33A	82%
GEM12I12-P1J	12V, 1.00A	82.5%
GEM12I15-P1J	15V, 0.80A	84%
GEM12I18-P1J	18V, 0.66A	85%
GEM12I24-P1J	24V, 0.50A	85%
GEM12I48-P1J	48V, 0.25A	87%

■ 插墙式(可更换插头型/Class II) — 18W

型号 (主体)	输出	效率
GEM18I05-P1J	5V, 3.00A	80%
GEM18I09-P1J	9V, 2.00A	84%
GEM18I12-P1J	12V, 1.50A	84%
GEM18I15-P1J	15V, 1.20A	84%
GEM18I18-P1J	18V, 1.00A	84%
GEM18I24-P1J	24V, 0.75A	85%
GEM18I48-P1J	48V, 0.38A	87%

■ 插墙式(可更换插头型/Class II) — 30W

型号 (主体)	输出	效率
GEM30I05-P1J	5V, 4.00A	82%
GEM30I07-P1J	7.5V, 3.33A	86%
GEM30I09-P1J	9V, 3.33A	87%
GEM30I12-P1J	12V, 2.50A	87%
GEM30I15-P1J	15V, 2.00A	87%
GEM30I18-P1J	18V, 1.66A	88%
GEM30I24-P1J	24V, 1.25A	88.5%
GEM30I48-P1J	48V, 0.625A	90%

■ 插墙式(可更换插头型/Class II) — 40W

型号 (主体)	输出	效率
GEM40I05-P1J	5V, 5.00A	84%
GEM40I09-P1J	9V, 4.00A	87%
GEM40I12-P1J	12V, 3.33A	88%
GEM40I15-P1J	15V, 2.66A	88%
GEM40I18-P1J	18V, 2.22A	88%
GEM40I24-P1J	24V, 1.66A	89%
GEM40I48-P1J	48V, 0.83A	90.5%

■ 插墙式(可更换插头型/Class II) — 60W

型号 (主体)	输出	效率
GEM60I05-P1J	5V, 6.00A	80%
GEM60I07-P1J	7.5V, 6.00A	85%
GEM60I09-P1J	9V, 5.50A	87%
GEM60I12-P1J	12V, 4.50A	88%
GEM60I15-P1J	15V, 4.00A	88%
GEM60I18-P1J	18V, 3.33A	88%
GEM60I24-P1J	24V, 2.50A	88%
GEM60I48-P1J	48V, 1.25A	90%

■ AC/DC 适配器 6~220W



▲ **GSM06U**
66x 32x 42.5mm



▲ **GSM06E**
66x 32x 42.5mm



▲ **GSM12U**
62.2x 27.4x 45.5mm



▲ **GSM12E**
62.2x 27.4x 45.5mm



USB 型

■ 插墙式 (Class II) — 6W

型号	输出	效率
GSM06□05-P1J	5V, 1.20A	68%
GSM06□06-P1J	6V, 1.00A	74%
GSM06□07-P1J	7.5V, 0.80A	74%
GSM06□09-P1J	9V, 0.66A	76%
GSM06□12-P1J	12V, 0.50A	77%
GSM06□15-P1J	15V, 0.40A	79%
GSM06□18-P1J	18V, 0.33A	80%
GSM06□24-P1J	24V, 0.25A	82%

□ = U/E ; U: 2级美式插头, E: 2级欧式插头

■ 插墙式 (Class II) — 12W

型号	输出	效率
GSM12□05-USB	5V, 2.40A	80%
GSM12□05-P1J	5V, 2.40A	80%
GSM12□07-P1J	7.5V, 1.60A	82%
GSM12□09-P1J	9V, 1.33A	82%
GSM12□12-P1J	12V, 1.00A	82.5%
GSM12□15-P1J	15V, 0.80A	84%
GSM12□18-P1J	18V, 0.66A	85%
GSM12□24-P1J	24V, 0.50A	85%
GSM12□48-P1J	48V, 0.25A	87%

□ = U/E ; U: 2级美式插头, E: 2级欧式插头

■ 可更换AC插头——GEM系列

Type	Single Unit				四种型号混合
	AC Plug-AU2	AC Plug-UK2	AC Plug-EU2	AC Plug-US2	AC Plug-Mix2
机构示意图					
	澳式	英式	欧式	美式	

备注：电源与AC插头需分开订购；电源需搭配任何一种插头使用。



▲ GSM18B/25B/36B
79x 54x 33mm



▲ GSM18U/25U/36U
79x 54x 33mm



▲ GSM18E/25E/36E
79x 54x 33mm



▲ GSM60U
75.5x 32x 47.5mm



▲ GSM60E
75.5x 32x 47.5mm



GSM 介绍

■ 桌上型/插墙式 (Class II) — 18W

型号	输出	效率
GSM18□05-P1J	5V, 3.00A	80%
GSM18□07-P1J	7.5V, 2.00A	83%
GSM18□09-P1J	9V, 2.00A	84%
GSM18□12-P1J	12V, 1.50A	85%
GSM18□15-P1J	15V, 1.20A	85.5%
GSM18□18-P1J	18V, 1.00A	86%
GSM18□24-P1J	24V, 0.75A	87%
GSM18□48-P1J	48V, 0.375A	88%

□ = B/U/E ; B: IEC320-C8, U: 2级美式插头, E: 2级欧式插头

■ 桌上型/插墙式 (Class II) — 36W

型号	输出	效率
GSM36□05-P1J	5V, 4.50A	80%
GSM36□07-P1J	7.5V, 4.32A	83%
GSM36□09-P1J	9V, 4.00A	84%
GSM36□12-P1J	12V, 3.00A	86%
GSM36□15-P1J	15V, 2.40A	87%
GSM36□18-P1J	18V, 2.00A	87%
GSM36□24-P1J	24V, 1.50A	87%
GSM36□48-P1J	48V, 0.75A	88%

□ = B/U/E ; B: IEC320-C8, U: 2级美式插头, E: 2级欧式插头

■ 桌上型/插墙式 (Class II) — 25W

型号	输出	效率
GSM25□05-P1J	5V, 4.00A	80%
GSM25□07-P1J	7.5V, 2.93A	83%
GSM25□09-P1J	9V, 2.77A	84%
GSM25□12-P1J	12V, 2.08A	86%
GSM25□15-P1J	15V, 1.66A	86%
GSM25□18-P1J	18V, 1.38A	86%
GSM25□24-P1J	24V, 1.04A	87%
GSM25□48-P1J	48V, 0.52A	88%

□ = B/U/E ; B: IEC320-C8, U: 2级美式插头, E: 2级欧式插头

■ 插墙式 (Class II) — 60W

型号	输出	效率
GSM60□05-P1J	5V, 6.00A	80.0%
GSM60□07-P1J	7.5V, 6.00A	85.0%
GSM60□09-P1J	9V, 5.50A	87.0%
GSM60□12-P1J	12V, 4.50A	88.0%
GSM60□15-P1J	15V, 4.00A	88.0%
GSM60□18-P1J	18V, 3.33A	88.0%
GSM60□24-P1J	24V, 2.50A	88.0%
GSM60□48-P1J	48V, 1.25A	90.0%

□ = U/E ; U: 2级美式插头, E: 2级欧式插头

■ 医疗 / 医院等级交流输出电源线

订单型号: YP18+YC12



■ AC/DC 适配器 6~220W



▲ GSM40/60 A/B
125x 50x 31.5mm



▲ GSM90 A/B
145x 60x 32mm



▲ GSM120 A/B
167x 67x 35mm



▲ GSM160 A/B
175x 72x 35mm



▲ GSM220 A/B
210x 85x 46mm

■ 桌上型 — 40W

型号	输出	效率
GSM40□05-P1J	5V, 5.00A	81.0%
GSM40□07-P1J	7.5V, 5.34A	85.5%
GSM40□09-P1J	9V, 4.45A	86.0%
GSM40□12-P1J	12V, 3.34A	88.0%
GSM40□15-P1J	15V, 2.67A	88.5%
GSM40□18-P1J	18V, 2.22A	89.5%
GSM40□24-P1J	24V, 1.67A	90.0%
GSM40□48-P1J	48V, 0.84A	91.0%

□=A/B ; A: IEC320-C14/Class I, B: IEC320-C8/Class II

■ 桌上型 — 60W

型号	输出	效率
GSM60□05-P1J	5V, 6.00A	81.5%
GSM60□07-P1J	7.5V, 6.00A	86.0%
GSM60□09-P1J	9V, 6.00A	87.5%
GSM60□12-P1J	12V, 5.00A	88.0%
GSM60□15-P1J	15V, 4.00A	88.5%
GSM60□18-P1J	18V, 3.33A	89.0%
GSM60□24-P1J	24V, 2.50A	90.0%
GSM60□48-P1J	48V, 1.25A	91.5%

□=A/B ; A: IEC320-C14/Class I, B: IEC320-C8/Class II

■ 桌上型 — 90W

型号	输出	效率
GSM90□12-P1M	12V, 6.67A	88.0%
GSM90□15-P1M	15V, 6.00A	89.0%
GSM90□19-P1M	19V, 4.74A	89.0%
GSM90□24-P1M	24V, 3.75A	90.0%
GSM90□48-P1M	48V, 1.87A	91.0%

□=A/B ; A: IEC320-C14/Class I, B: IEC320-C8/Class II

■ 桌上型 — 120W

型号	输出	效率
GSM120□12-R7B	12V, 8.5A	88.0%
GSM120□15-R7B	15V, 7.00A	89.0%
GSM120□20-R7B	20V, 6.00A	89.0%
GSM120□24-R7B	24V, 5.00A	90.0%
GSM120□48-R7B	48V, 2.50A	91.5%

□=A/B ; A: IEC320-C14/Class I, B: IEC320-C8/Class II

■ 桌上型 — 160W

型号	输出	效率
GSM160□12-R7B	12V, 11.5A	90.0%
GSM160□15-R7B	15V, 9.6A	91.0%
GSM160□20-R7B	20V, 8.0A	92.5%
GSM160□24-R7B	24V, 6.67A	93.0%
GSM160□48-R7B	48V, 3.34A	94.0%

□=A/B ; A: IEC320-C14/Class I, B: IEC320-C8/Class II

■ 桌上型 — 220W

型号	输出	效率
GSM220A12-R7B	12V, 15.0A	90.0%
GSM220A15-R7B	15V, 13.4A	90.0%
GSM220A20-R7B	20V, 11.0A	92.0%
GSM220A24-R7B	24V, 9.20A	93.5%
GSM220A48-R7B	48V, 4.60A	94.5%

□=A/B ; A: IEC320-C14/Class I, B: IEC320-C8/Class II

■ AC 接口

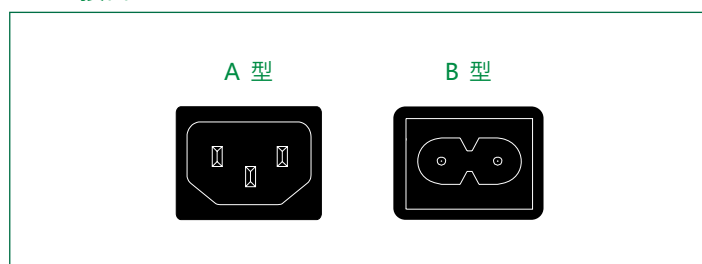

可变直流插头选择指南

- 少量需求的灵活解决方案
- 易于修改, 适合不同尺寸的直流插头

· 现货出售, 无最小起订量

※ 如果您在此表中找不到所需的DC插头, 请与MEAN WELL的销售代表联系。

适配器	可变直流插头	组装图 (案例)
<p>机型</p> <p>GST18~60 GSM06~60 GEM06~60 GE12~40 SGA12~60 GS06/15 OWA-60U/E</p>  <p>P1J Standard DC Plug 2.1x 5.5x 11mm</p>	<p>Ordering No.</p> <p>DC PLUG-P1J-P1I 2.1x 5.5x 9.5mm DC PLUG-P1J-P1M 2.5x 5.5x 11mm DC PLUG-P1J-P1L 2.5x 5.5x 9.5mm DC PLUG-P1J-P3A 0.7x 2.35x 11mm DC PLUG-P1J-P3B 1.7x 4.0x 11mm DC PLUG-P1J-P3C 1.7x 4.75x 11mm DC PLUG-P1J-P4A 3.4x 5.5x 11x 1mm DC PLUG-P1J-P4B 4.4x 6.5x 11x 1.4mm DC PLUG-P1J-P4C 5.1x 7.4x 11x 0.6mm DC PLUG-P1J-P1IR 2.1x 5.5x 9.5mm DC PLUG-P1J-P1MR 2.5x 5.5x 11mm DC PLUG-P1J-P1LR 2.5x 5.5x 9.5mm DC PLUG-P1J-P1JR 2.1x 5.5x 11mm DC PLUG-P1J-R6B KYCON KPPX-3P DC PLUG-P1J-R7B KYCON KPPX-4P DC PLUG-P1J-R1B 5PIN DIN</p>	
<p>机型</p> <p>GST90~120 GSM90</p>  <p>P1M Standard DC Plug 2.5x 5.5x 11mm</p>	<p>Ordering No.</p> <p>DC PLUG-P1M-P1J 2.1x 5.5x 11mm DC PLUG-P1M-P1JR 2.1x 5.5x 11mm DC PLUG-P1M-R7B KYCON KPPX-4P</p>	
<p>机型</p> <p>GST120~220 GSM120~220 OWA-90U/120U</p>  <p>R7B KPPX-4P Equivalent</p>	<p>Ordering No.</p> <p>DC PLUG-R7BF-P1J 2.1x 5.5x 11mm DC PLUG-R7BF-P1M 2.5x 5.5x 11mm</p>	

备注: 有关DC插头的额定值和兼容性, 请参阅MEAN WELL适配器规格。



AC/DC 基板型

30~500W

特性

- 小型化尺寸: 3" x 2", 4" x 2", 5" x 3", 7" x 4.2"
- 单组和多组输出选择
- 通过医疗类安规认证 (2xMOPP)
- 适用于BF等级应用需求
(除 RPS/D/T-75)
- Class I & II 机型可选
- 低漏电流 < 100~300μA
- 空载损耗 < 0.1~0.75W
- 遥控开关功能 ON/OFF, 遥感, 5V 备用输出,
12V 辅助输出, P.G./P.F. 信号可选
- 3 年保固

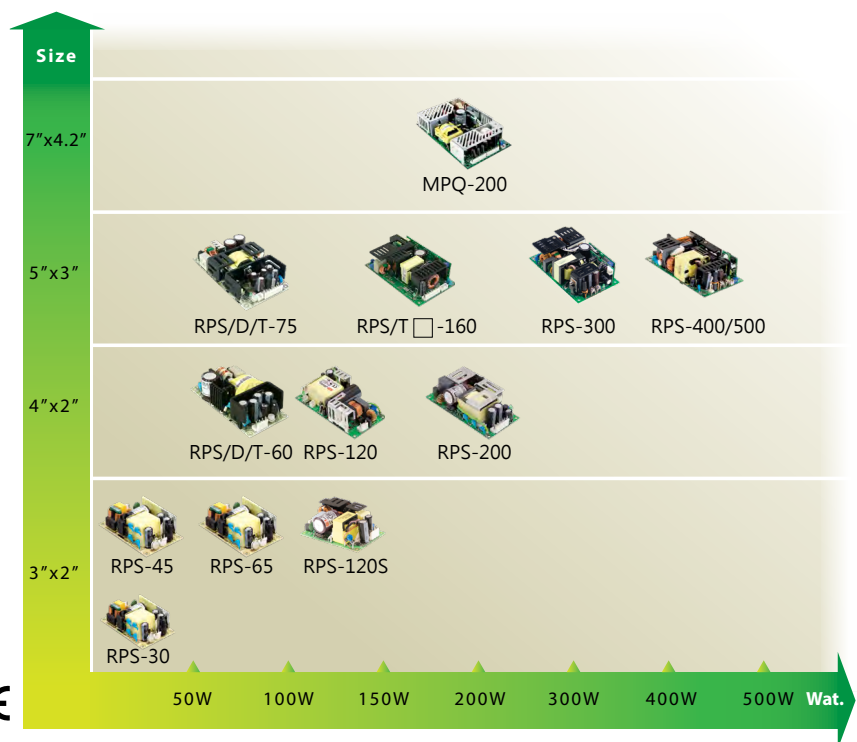



▲ RPS-30/45/65
76.2x 50.8x 24mm
(3" x 2")



▲ RPS-120S
76.2x 50.8x 28mm
(3" x 2")



▲ RPS/D/T□-60
101.6x 50.8x 29mm
(4" x 2")

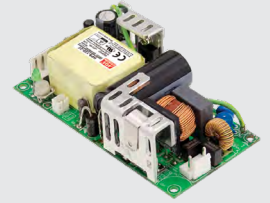

▲ RPS-120
101.6x 50.8x 29mm
(4" x 2")

■ 30W: 单组输出 — Class II

型号	输出 (额定电流/电流峰值)	效率
RPS-30-3.3	3.3V, 6A / 6.60A	80.0%
RPS-30-5	5V, 6A / 6.60A	82.0%
RPS-30-7.5	7.5V, 4A / 4.40A	84.0%
RPS-30-12	12V, 2.5A / 2.75A	88.0%
RPS-30-15	15V, 2A / 2.20A	89.0%
RPS-30-24	24V, 1.25A / 1.375A	89.5%
RPS-30-48	48V, 0.625A / 0.687A	92.0%

■ 45W: 单组输出 — Class II

型号	输出 (额定电流/电流峰值)	效率
RPS-45-3.3	3.3V, 8A / 8.80A	80.5%
RPS-45-5	5V, 8A / 8.80A	83.0%
RPS-45-7.5	7.5V, 5.4A / 5.95A	85.0%
RPS-45-12	12V, 3.8A / 4.18A	88.0%
RPS-45-15	15V, 3A / 3.30A	89.0%
RPS-45-24	24V, 1.9A / 2.10A	90.0%
RPS-45-48	48V, 0.94A / 1.03A	91.0%

■ 65W: 单组输出 — Class II

型号	输出 (额定电流/电流峰值)	效率
RPS-65-3.3	3.3V, 10A / 11A	80.0%
RPS-65-5	5V, 10A / 11A	84.0%
RPS-65-7.5	7.5V, 8A / 8.80A	85.0%
RPS-65-12	12V, 5.42A / 5.96A	88.0%
RPS-65-15	15V, 4.34A / 4.77A	89.0%
RPS-65-24	24V, 2.71A / 2.98A	90.0%
RPS-65-48	48V, 1.36A / 1.49A	91.0%

■ 120W: 单组输出 — Class I or II

型号	输出 (额定电流/电流峰值)	效率
RPS-120S-12	12V, 9.5A / 11.8A	91.0%
RPS-120S-15	15V, 7.6A / 9.5A	92.0%
RPS-120S-24	24V, 5A / 6.25A	93.0%
RPS-120S-27	27V, 4.44A / 5.55A	94.0%
RPS-120S-48	48V, 2.5A / 3.125A	93.5%

■ 60W: 单组输出 — Class I

型号	输出 (额定电流/电流峰值)	效率
RPS-60-3.3	3.3V, 10A / 11A	74.0%
RPS-60-5	5V, 10A / 11A	79.0%
RPS-60-12	12V, 5A / 5.5A	83.0%
RPS-60-15	15V, 4A / 4.4A	84.0%
RPS-60-24	24V, 2.5A / 2.75A	85.0%
RPS-60-48	48V, 1.25A / 1.375A	86.0%

■ 60W: 双组输出 — Class I

型号	输出	效率	最大功率
RPD-60A	5V, 0.5~5.5A 12V, 0.1~2.2A	78%	54W
RPD-60B	5V, 0.5~3.85A 24V, 0.1~1.65A	82%	59W

■ 60W: 三组输出 — Class I

型号	输出	效率	最大功率
RPT-60A	5V, 0.5~4.4A 12V, 0.1~2.2A -5V, 0.1~0.55A	77%	51W
RPT-60B	5V, 0.5~4.4A 12V, 0.1~2.2A -12V, 0.1~0.55A	78%	55W
RPT-60C	5V, 0.5~4.4A 15V, 0.1~1.65A -15V, 0.1~0.55A	79%	55W
RPT-60D	5V, 0.5~3.85A 24V, 0.1~1.1A 12V, 0.1~0.55A	79%	52W
RPT-6003	3.3V, 0.5~5.5A 5V, 0.3~3.3A 12V, 0.1~0.77A	75%	44W

■ 120W: 单组输出 — Class I or II

型号	输出 (对流/10CFM)	效率
RPS-120-12	12V, 7A / 10A	89.0%
RPS-120-15	15V, 5.6A / 8A	89.0%
RPS-120-24	24V, 3.5A / 5A	90.0%
RPS-120-27	27V, 3.15A / 4.5A	90.0%
RPS-120-48	48V, 1.75A / 2.5A	91.0%

■ AC/DC 基板型 30~500W



▲ **RPS-200**
101.6x 50.8x 29mm
(4" x 2")



▲ **RPS/D/T-75**
127x 76.2x 31mm
(5" x 3")



▲ **RPS/T-160**
127x 76.2x 34.6mm
(5" x 3")

■ 75W: 单组输出 — Class I

型号	输出 (额定/23.5CFM)	效率
RPS-75-3.3	3.3V, 15A / 20A	73%
RPS-75-5	5V, 14A / 18.7A	78%
RPS-75-12	12V, 6.3A / 8.3A	82%
RPS-75-15	15V, 5A / 6.7A	83%
RPS-75-24	24V, 3.2A / 4.2A	85%
RPS-75-36	36V, 2.1A / 2.8A	86%
RPS-75-48	48V, 1.6A / 2.1A	86%

■ 75W: 双组输出 — Class I

型号	输出	效率	最大功率
RPD-75A	5V, 1.0~9.5A	77%	96W
	12V, 0.3~4.0A		
RPD-75B	5V, 1.0~6.8A	79%	99W
	24V, 0.2~2.7A		

■ 75W: 三组输出 — Class I

型号	输出	效率	最大功率
RPT-75A	5V, 0.6~8.0A	76%	93W
	12V, 0.2~4.0A		
	-5V, 0.1~1.0A		
RPT-75B	5V, 0.6~8.0A	77%	100W
	12V, 0.2~4.0A		
	-12V, 0.1~1.0A		
RPT-75C	5V, 0.6~8.0A	77%	100W
	15V, 0.1~3.0A		
	-15V, 0.1~1.0A		
RPT-75D	5V, 0.6~7.0A	79%	95W
	24V, 0.1~2.0A		
	12V, 0.1~1.0A		
RPT-7503	3.3V, 0.7~7.0A	74%	81W
	5V, 0.0~8.0A		
	12V, 0.0~1.5A		

■ 200W: 单组输出 — Class I or II

型号	输出 (对流/10CFM)	效率
RPS-200-12	12V, 11.7A / 16.7A	93.0%
RPS-200-15	15V, 9.4A / 13.4A	93.5%
RPS-200-24	24V, 5.9A / 8.4A	94.0%
RPS-200-27	27V, 5.3A / 7.5A	94.0%
RPS-200-48	48V, 3A / 4.2A	95.0%

■ 160W: 单组输出 — Class I

型号	输出 (对流/20.5CFM)	效率
RPS□-160-5	5V, 20A / 30A	86%
RPS□-160-12	12V, 9.1A / 12.9A	87%
RPS□-160-15	15V, 7.3A / 10.3A	87%
RPS□-160-24	24V, 4.6A / 6.5A	87%
RPS□-160-48	48V, 2.3A / 3.25A	88%

□ = 空白, G; 空白: 基本功能, G: 5V待机/0.8A & 空载损耗 < 0.75W

■ 160W: 三组输出 — Class I

型号	输出	效率	最大功率
RPT□-160A	5V, 0.6~14A	84%	145W
	12V, 0.2~5.5A		
	-5V, 0.1~1.0A		
RPT□-160B	5V, 0.6~14A	84%	146W
	12V, 0.2~5.0A		
	-12V, 0.1~1.0A		
RPT□-160C	5V, 0.6~14A	83%	143W
	15V, 0.1~3.6A		
	-15V, 0.1~1.0A		
RPT□-160D	5V, 0.3~11A	83%	148W
	12V, 0.2~5.0A		
	24V, 0.15~1.2A		

□ = 空白, G; 空白: 基本功能, G: 5V待机/0.8A & 空载损耗 < 0.75W



▲ **RPS-300**
127x 76.2x 35mm
(5" x3")



▲ **RPS-400**
127x 76.2x 35mm
(5" x3")

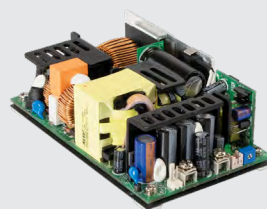

▲ **RPS-500**
127x 76.2x 41mm
(5" x3")



▲ **MPQ-200**
177.8x 107.2x 35.5mm
(7" x4.2")

■ 300W: 单组输出 — Class I

型号	输出 (对流/20.5CFM)	效率
RPS-300-12	12V, 16.67A / 25A	90.0%
RPS-300-15	15V, 13.33A / 20A	90.0%
RPS-300-24	24V, 8.33A / 12.5A	92.5%
RPS-300-27	27V, 7.4A / 11.12A	93.0%
RPS-300-48	48V, 4.17A / 6.25A	93.0%

■ 400W: 单组输出 — Class I or II

型号	输出 (对流/25CFM)	效率
RPS-400-12	12V, 20.8A / 33.3A	91.5%
RPS-400-15	15V, 16.7A / 26.7A	92.0%
RPS-400-18	18V, 13.9A / 22.3A	93.0%
RPS-400-24	24V, 10.5A / 16.7A	93.0%
RPS-400-27	27V, 9.3A / 14.9A	93.5%
RPS-400-36	36V, 7A / 11.2A	94.0%
RPS-400-48	48V, 5.3A / 8.4A	94.0%

■ 500W: 单组输出 — Class I or II

型号	输出 (对流/25CFM)	效率
RPS-500-12	12V, 41.6A / 26.7A	91.0%
RPS-500-15	15V, 33.3A / 21.3A	92.0%
RPS-500-18	18V, 27.8A / 17.8A	92.5%
RPS-500-24	24V, 20.8A / 13.4A	93.0%
RPS-500-27	27V, 18.5A / 11.9A	93.5%
RPS-500-36	36V, 13.9A / 8.9A	94.0%
RPS-500-48	48V, 10.4A / 6.7A	94.0%

■ 200W: 四组输出 — Class I

型号	输出	效率	最大功率
MPQ-200B	5V, 3.0~18A	78%	193W
	12V, 0.7~8.4A		
	-5V, 0.0~2.4A		
	-12V, 0.0~2.4A		
MPQ-200C	5V, 3.0~18A	78%	190W
	15V, 0.5~6.0A		
	-5V, 0.0~2.4A		
	-15V, 0.0~2.4A		
MPQ-200D	5V, 3.0~18A	79%	195W
	24V, 0.3~3.6A		
	12V, 0.0~2.4A		
	-12V, 0.0~2.4A		
MPQ-200F	5V, 3.0~18A	81%	200W
	24V, 0.3~3.3A		
	15V, 0.0~2.4A		
	-15V, 0.0~2.4A		



AC/DC 板上型

5~90W

特性

- PCB安装, 外型小巧
- 输出电压从3.3V ~ 48V 可选
- 医疗类安规认证 (2xMOPP)
- 适用于 BF 等级应用需求
- Class II 等级
- 峰值功率高达 110%
- 无需附加组件即可符合 EMI class B
- 低漏电压 <math><80\sim300\mu A</math>
- 空载消耗 <math><0.075\sim0.1W</math>
- 工作温度: $-40\sim+85^{\circ}C$
- 锁螺丝端子安装可选 (仅30~90W)
- 3 年保固





▲ MFM-05/10
42x 22.3x 20.5mm



▲ MFM-15/20
49x 23.8x 23mm

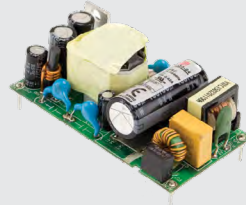

▲ MFM-30
65.5x 35x 23mm



MPM/MFM 介绍

■ 5W: 单组输出 — Class II

型号	输出 / 峰值电流(10 秒)	效率
MFM-05-3.3	3.3V, 1.25A / 1.38A	74%
MFM-05-5	5V, 1.00A / 1.10A	80%
MFM-05-12	12V, 0.42A / 0.46A	80%
MFM-05-15	15V, 0.33A / 0.36A	81%
MFM-05-24	24V, 0.23A / 0.25A	82%

■ 20W: 单组输出 — Class II

型号	输出 / 峰值电流(10 秒)	效率
MFM-20-3.3	3.3V, 4.50A / 4.95A	81%
MFM-20-5	5V, 4.00A / 4.40A	85%
MFM-20-12	12V, 1.80A / 1.98A	85.5%
MFM-20-15	15V, 1.40A / 1.54A	87%
MFM-20-24	24V, 0.90A / 0.99A	87%

■ 10W: 单组输出 — Class II

型号	输出 / 峰值电流(10 秒)	效率
MFM-10-3.3	3.3V, 2.50A / 2.75A	78%
MFM-10-5	5V, 2.00A / 2.20A	81%
MFM-10-12	12V, 0.85A / 0.94A	83%
MFM-10-15	15V, 0.67A / 0.74A	83%
MFM-10-24	24V, 0.42A / 0.46A	84%

■ 30W: 单组输出 — Class II

型号	输出 / 峰值电流(10 秒)	效率
MFM-30-3.3	3.3V, 6.00A / 7.8A	82.5%
MFM-30-5	5V, 6.00A / 6.9A	86.5%
MFM-30-12	12V, 2.50A / 2.9A	90%
MFM-30-15	15V, 2.00A / 2.3A	89%
MFM-30-24	24V, 1.30A / 1.5A	90%
MFM-30-48	48V, 0.63A / 0.73A	91%

■ 15W: 单组输出 — Class II

型号	输出 / 峰值电流(10 秒)	效率
MFM-15-3.3	3.3V, 3.50A / 3.85A	83.5%
MFM-15-5	5V, 3.00A / 3.30A	85.5%
MFM-15-12	12V, 1.25A / 1.38A	86.5%
MFM-15-15	15V, 1.00A / 1.10A	87.0%
MFM-15-24	24V, 0.63A / 0.69A	86.5%

■ MFM 系列机构尺寸

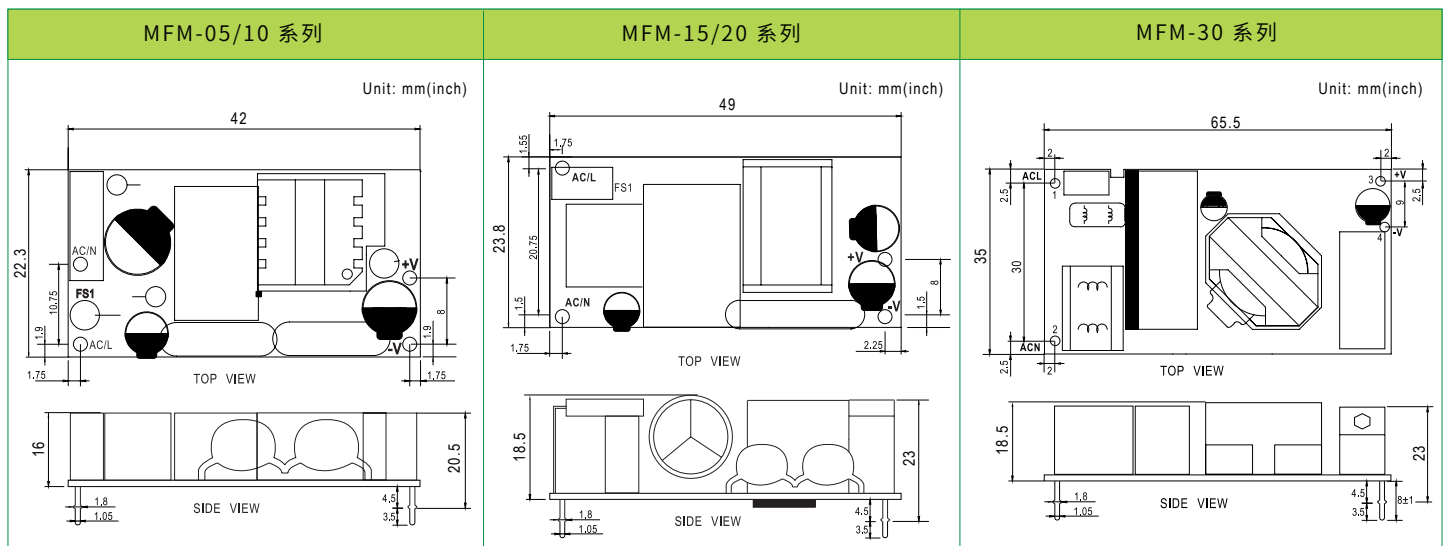



▲ **MPM-05/10**
45.7x 25.4x 21.5mm



▲ **MPM-15/20**
52.4x 27.2x 24mm



MPM/MFM 介绍

■ 5W: 单组输出 — Class II

型号	输出 / 峰值电流(10 秒)	效率
MPM-05-3.3	3.3V, 1.25A / 1.38A	74%
MPM-05-5	5V, 1.00A / 1.10A	80%
MPM-05-12	12V, 0.42A / 0.46A	80%
MPM-05-15	15V, 0.33A / 0.36A	81%
MPM-05-24	24V, 0.23A / 0.25A	82%

■ 15W: 单组输出 — Class II

型号	输出 / 峰值电流(10 秒)	效率
MPM-15-3.3	3.3V, 3.50A / 3.85A	83.5%
MPM-15-5	5V, 3.00A / 3.30A	85.5%
MPM-15-12	12V, 1.25A / 1.38A	86.5%
MPM-15-15	15V, 1.00A / 1.10A	87%
MPM-15-24	24V, 0.63A / 0.69A	86.5%

■ 10W: 单组输出 — Class II

型号	输出 / 峰值电流(10 秒)	效率
MPM-10-3.3	3.3V, 2.50A / 2.75A	78%
MPM-10-5	5V, 2.00A / 2.20A	81%
MPM-10-12	12V, 0.85A / 0.94A	83%
MPM-10-15	15V, 0.67A / 0.74A	83%
MPM-10-24	24V, 0.42A / 0.46A	84%

■ 20W: 单组输出 — Class II

型号	输出 / 峰值电流(10 秒)	效率
MPM-20-3.3	3.3V, 4.50A / 4.95A	81%
MPM-20-5	5V, 4.00A / 4.40A	85%
MPM-20-12	12V, 1.80A / 1.98A	85.5%
MPM-20-15	15V, 1.40A / 1.54A	87%
MPM-20-24	24V, 0.90A / 0.99A	87%

■ MPM 系列机构尺寸

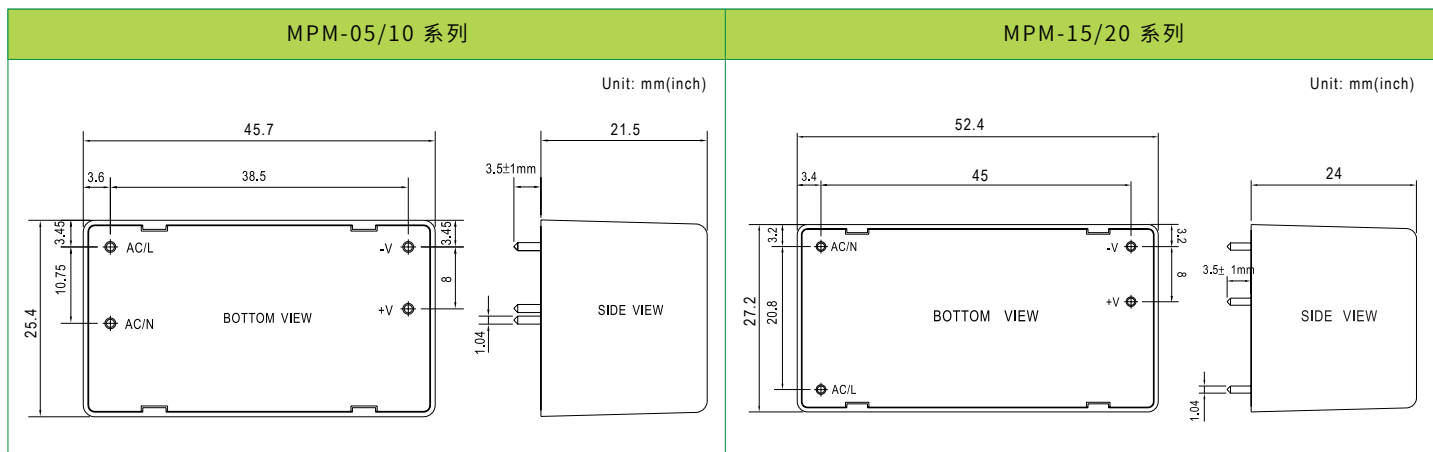



▲ MPM-30
69.5x 39x 24mm



▲ MPM-30-xST
91x 39.5x 28.5mm



▲ MPM-45/65/90
87x52x 29.5mm



▲ MPM-45/65/90-xST
109x 52x 33.5mm

■ 30W: 单组输出 — Class II

型号	输出 / 峰值电流(10 秒)	效率
MPM-30-3.3□	3.3V, 6.00A / 7.8A	82.5%
MPM-30-5□	5V, 6.00A / 6.9A	86.5%
MPM-30-12□	12V, 2.50A / 2.9A	90%
MPM-30-15□	15V, 2.00A / 2.3A	89%
MPM-30-24□	24V, 1.30A / 1.5A	90%
MPM-30-48□	48V, 0.63A / 0.73A	91%

□ = 空白, ST; 空白: PCB 安装式, ST: 锁螺丝端子型

■ 65W: 单组输出 — Class II

型号	输出 / 峰值电流(10 秒)	效率
MPM-65-5□	5V, 10A / 11A	86.5%
MPM-65-12□	12V, 5.42A / 5.96A	92.5%
MPM-65-15□	15V, 4.33A / 4.77A	92.5%
MPM-65-24□	24V, 2.71A / 2.98A	93.0%
MPM-65-48□	48V, 1.36A / 1.49A	92.0%

□ = 空白, ST; 空白: PCB 安装式, ST: 锁螺丝端子型

■ 45W: 单组输出 — Class II

型号	输出 / 峰值电流(10 秒)	效率
MPM-45-5□	5V, 8.0A / 8.80A	88.0%
MPM-45-12□	12V, 3.75A / 4.13A	91.5%
MPM-45-15□	15V, 3.0A / 3.30A	92.5%
MPM-45-24□	24V, 1.88A / 2.10A	92.5%
MPM-45-48□	48V, 0.94A / 1.05A	92.0%

□ = 空白, ST; 空白: PCB 安装式, ST: 锁螺丝端子型

■ 90W: 单组输出 — Class II

型号	输出 / 峰值电流(10 秒)	效率
MPM-90-12□	12V, 6.7A / 7.37A	92.0%
MPM-90-15□	15V, 5.67A / 6.23A	92.5%
MPM-90-24□	24V, 3.75A / 4.13A	93.0%
MPM-90-48□	48V, 1.88A / 2.07A	93.0%

□ = 空白, ST; 空白: PCB 安装式, ST: 锁螺丝端子型

■ MPM 系列机构尺寸

MPM-30 系列	MPM-45/65/90 系列
<p>Unit: mm(inch)</p>	<p>Unit: mm(inch)</p>
	<p>AC/L, AC/N P/N diameter: 1φ +Vo, -Vo P/N diameter: 2φ</p>



AC/DC机壳型

100~1200W

特性

- 通过医疗类安规认证
(NMP/RPS-C 系列为2xMOPP, MSP 系列为MOOP)
- 适用于 BF 等级应用需求 (NMP/RPS-C 系列)
- 输出电压从 3V ~ 55V 可选
- Class I 等级
- 低漏电流 <math><100\sim450\mu A</math>
- 空载损耗 <math><0.3\sim0.8W</math>
- 内置遥控开关功能, 遥感, 5V 备用输出, 12V 辅助输出, DC OK 信号可选
- 工作温度: $-40\sim+70^{\circ}C$
- 5 年保固 (NMP/MSP 系列)
3 年保固 (RPS-C 系列)





▲ RPS-120/200-x-C
103.4x 62x 40mm



▲ RPS-300-x-C
130x 86x 43mm



▲ RPS-400/500-x-C
130x 86x 43mm



▲ RPS-400/500-x-TF
130x 86x 66.5mm

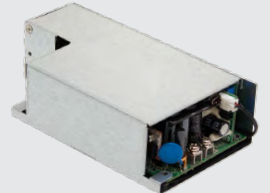

▲ RPS-400/500-x-SF
160x 86x 43mm

■ 120W: 单组输出 — Class I

型号	输出 (对流/10CFM)	效率
RPS-120-12-C	12V, 7A / 10A	89.0%
RPS-120-15-C	15V, 5.6A / 8A	89.0%
RPS-120-24-C	24V, 3.5A / 5A	90.0%
RPS-120-27-C	27V, 3.15A / 4.5A	90.0%
RPS-120-48-C	48V, 1.75A / 2.5A	91.0%

■ 200W: 单组输出 — Class I

型号	输出 (对流/20.5CFM)	效率
RPS-200-12-C	12V, 11.7A / 16.7A	93.0%
RPS-200-15-C	15V, 9.4A / 13.4A	93.5%
RPS-200-24-C	24V, 5.9A / 8.4A	94.0%
RPS-200-27-C	27V, 5.3A / 7.5A	94.0%
RPS-200-48-C	48V, 3A / 4.2A	95.0%

■ 300W: 单组输出 — Class I

型号	输出 (对流/20.5CFM)	效率
RPS-300-12-C	12V, 16.67A / 25A	90.0%
RPS-300-15-C	15V, 13.33A / 20A	90.0%
RPS-300-24-C	24V, 8.33A / 12.5A	92.5%
RPS-300-27-C	27V, 7.4A / 11.12A	93.0%
RPS-300-48-C	48V, 4.17A / 6.25A	93.0%

■ 400W: 单组输出 — Class I

型号	输出 (对流/25CFM)	效率
RPS-400-12□	12V, 20.8A / 33.3A	91.5%
RPS-400-15□	15V, 16.7A / 26.7A	92.0%
RPS-400-18□	18V, 13.9A / 22.3A	93.0%
RPS-400-24□	24V, 10.5A / 16.7A	93.0%
RPS-400-27□	27V, 9.3A / 14.9A	93.5%
RPS-400-36□	36V, 7A / 11.2A	94.0%
RPS-400-48□	48V, 5.3A / 8.4A	94.0%

□=-C, -TF, -SF;
-C: 机壳型, -TF: 顶置风扇, -SF: 侧置风扇

■ 500W: 单组输出 — Class I

型号	输出 (对流/25CFM)	效率
RPS-500-12□	12V, 26.7A / 41.6A	91.5%
RPS-500-15□	15V, 21.3A / 33.3A	92.0%
RPS-500-18□	18V, 17.8A / 27.8A	93.0%
RPS-500-24□	24V, 13.4A / 20.8A	93.0%
RPS-500-27□	27V, 11.9A / 18.5A	93.5%
RPS-500-36□	36V, 8.9A / 13.9A	94.0%
RPS-500-48□	48V, 6.7A / 10.4A	94.0%

□=-C, -TF, -SF;
-C: 机壳型, -TF: 顶置风扇, -SF: 侧置风扇

	RPS-400/500-C	RPS-400/500-TF	RPS-400/500-SF
无风扇	250W/320W	---	---
有风扇	400W/500W	400W/500W	400W/500W
示意图			

■ AC/DC 机壳型 100~1200W



▲ **MSP-100**
159x 97x 38mm

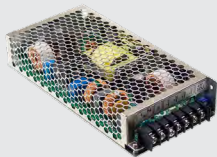

▲ **MSP-200**
199x 98x 38mm



▲ **MSP-300**
199x 105x 41mm



▲ **MSP-450**
218x 105x 41mm



▲ **MSP-600/1000**
218x 105x 63.5mm

■ 100W: 单组输出 — Class I

型号	输出	效率
MSP-100-3.3	3.3V, 20A	78.0%
MSP-100-5	5V, 17A	83.0%
MSP-100-7.5	7.5V, 13.5A	84.0%
MSP-100-12	12V, 8.5A	87.5%
MSP-100-15	15V, 7A	88.0%
MSP-100-24	24V, 4.5A	88.5%
MSP-100-36	36V, 2.9A	89.0%
MSP-100-48	48V, 2.2A	90.0%

■ 450W: 单组输出 — Class I

型号	输出	效率
MSP-450-3.3	3.3V, 90A	80.0%
MSP-450-5	5V, 90A	83.0%
MSP-450-7.5	7.5V, 60A	86.5%
MSP-450-12	12V, 37.5A	88.0%
MSP-450-15	15V, 30A	89.0%
MSP-450-24	24V, 18.8A	88.0%
MSP-450-36	36V, 12.5A	89.0%
MSP-450-48	48V, 9.5A	89.5%

■ 200W: 单组输出 — Class I

型号	输出	效率
MSP-200-3.3	3.3V, 40A	80.0%
MSP-200-5	5V, 35A	84.0%
MSP-200-7.5	7.5V, 26.7A	86.0%
MSP-200-12	12V, 16.7A	88.0%
MSP-200-15	15V, 13.4A	88.0%
MSP-200-24	24V, 8.4A	88.0%
MSP-200-36	36V, 5.7A	89.0%
MSP-200-48	48V, 4.3A	89.0%

■ 600W: 单组输出 — Class I

型号	输出	效率
MSP-600-3.3	3.3V, 120A	78.5%
MSP-600-5	5V, 120A	82.0%
MSP-600-7.5	7.5V, 80A	86.0%
MSP-600-12	12V, 53A	88.0%
MSP-600-15	15V, 43A	88.0%
MSP-600-24	24V, 27A	88.0%
MSP-600-36	36V, 17.5A	89.0%
MSP-600-48	48V, 13A	89.0%

■ 300W: 单组输出 — Class I

型号	输出	效率
MSP-300-3.3	3.3V, 60A	80.0%
MSP-300-5	5V, 60A	82.0%
MSP-300-7.5	7.5V, 40A	86.0%
MSP-300-12	12V, 27A	88.0%
MSP-300-15	15V, 22A	88.0%
MSP-300-24	24V, 14A	87.0%
MSP-300-36	36V, 9A	88.0%
MSP-300-48	48V, 7A	89.0%

■ 1000W: 单组输出 — Class I

型号	输出	效率
MSP-1000-12	12V, 80A	91.5%
MSP-1000-15	15V, 64A	92.0%
MSP-1000-24	24V, 42A	93.0%
MSP-1000-48	48V, 21A	94.0%



DC/DC 转换器

1~20W

特性

- 多种封装: SIP7, DIP
- 低漏电流 $<2\mu\text{A} \sim 5\mu\text{A}$
- 2 x MOOP / 2 x MOPP
- 输入/输出隔离: 6KVDC / 4.2KVAC 或 4KVAC
- 不同输入范围 ($\pm 10\%$, 2:1)
- 通过ANSI/AAMI ES60601-1 医疗安全认证
- 工作温度: $-40 \sim +90^\circ\text{C}$
- 3 年保固



(1~2W)



(15~20W)



(1~2W)





▲ **MDS01/02**
19.5x 9.8x 12.5mm
(0.77" x 0.39" x 0.49")



▲ **MDD01/02**
19.5x 9.8x 12.5mm
(0.77" x 0.39" x 0.49")

■ MDS01: 1W 单组输出

型号	输入	输出	效率
MDS01L-03	5V (4.5~5.5V)	3.3V, 303mA	73%
MDS01L-05	5V (4.5~5.5V)	5V, 200mA	78%
MDS01L-12	5V (4.5~5.5V)	12V, 84mA	77%
MDS01L-15	5V (4.5~5.5V)	15V, 67mA	75%
MDS01M-05	12V (10.8~13.2V)	5V, 200mA	78%
MDS01M-12	12V (10.8~13.2V)	12V, 84mA	82%
MDS01M-15	12V (10.8~13.2V)	15V, 67mA	83%
MDS01N-05	24V (21.6~26.4V)	5V, 200mA	77%
MDS01N-12	24V (21.6~26.4V)	12V, 84mA	79%
MDS01N-15	24V (21.6~26.4V)	15V, 67mA	79%

■ MDD01: 1W 双组输出

型号	输入	输出	效率
MDD01L-05	5V (4.5~5.5V)	±5V, ±100mA	79%
MDD01L-09	5V (4.5~5.5V)	±9V, ±56mA	81%
MDD01L-12	5V (4.5~5.5V)	±12V, ±42mA	77%
MDD01L-15	5V (4.5~5.5V)	±15V, ±34mA	77%
MDD01M-05	12V (10.8~13.2V)	±5V, ±100mA	78%
MDD01M-09	12V (10.8~13.2V)	±9V, ±56mA	82%
MDD01M-12	12V (10.8~13.2V)	±12V, ±42mA	75%
MDD01M-15	12V (10.8~13.2V)	±15V, ±34mA	76%
MDD01N-05	24V (21.6~26.4V)	±5V, ±100mA	77%
MDD01N-09	24V (21.6~26.4V)	±9V, ±56mA	79%
MDD01N-12	24V (21.6~26.4V)	±12V, ±42mA	77%
MDD01N-15	24V (21.6~26.4V)	±15V, ±34mA	77%

■ MDS02: 2W 单组输出

型号	输入	输出	效率
MDS02L-05	5V (4.5~5.5V)	5V, 400mA	77%
MDS02L-12	5V (4.5~5.5V)	12V, 167mA	80%
MDS02L-15	5V (4.5~5.5V)	15V, 133mA	79%
MDS02M-05	12V (10.8~13.2V)	5V, 400mA	75%
MDS02M-12	12V (10.8~13.2V)	12V, 167mA	83%
MDS02M-15	12V (10.8~13.2V)	15V, 133mA	84%
MDS02N-05	24V (21.6~26.4V)	5V, 400mA	80%
MDS02N-12	24V (21.6~26.4V)	12V, 167mA	83%
MDS02N-15	24V (21.6~26.4V)	15V, 133mA	85%

■ MDD02: 2W 双组输出

型号	输入	输出	效率
MDD02L-05	5V (4.5~5.5V)	±5V, ±200mA	78%
MDD02L-09	5V (4.5~5.5V)	±9V, ±111mA	81%
MDD02L-12	5V (4.5~5.5V)	±12V, ±83mA	78%
MDD02L-15	5V (4.5~5.5V)	±15V, ±67mA	79%
MDD02M-05	12V (10.8~13.2V)	±5V, ±200mA	78%
MDD02M-09	12V (10.8~13.2V)	±9V, ±111mA	83%
MDD02M-12	12V (10.8~13.2V)	±12V, ±83mA	83%
MDD02M-15	12V (10.8~13.2V)	±15V, ±67mA	82%
MDD02N-05	24V (21.6~26.4V)	±5V, ±200mA	77%
MDD02N-09	24V (21.6~26.4V)	±9V, ±111mA	83%
MDD02N-12	24V (21.6~26.4V)	±12V, ±83mA	82%
MDD02N-15	24V (21.6~26.4V)	±15V, ±67mA	82%

MDS01 & MDD01

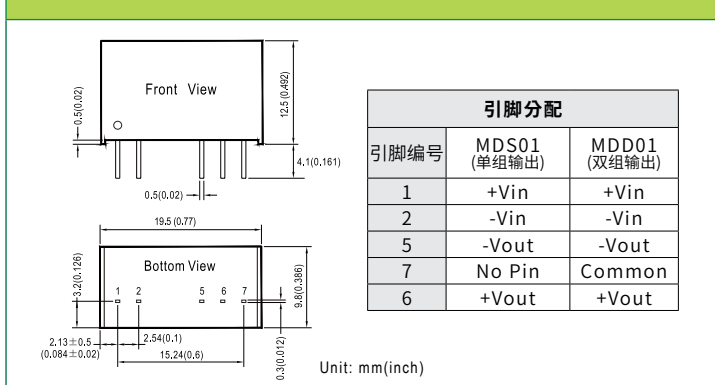

MDS02 & MDD02

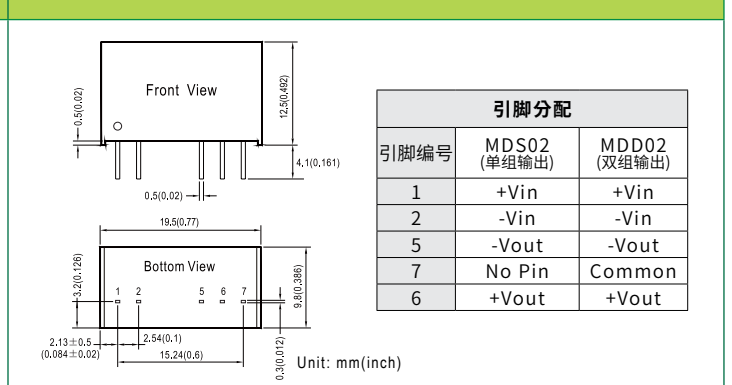

DC/DC 转换器 1~20W



▲ **MDS15**
50.8x 25.4x12mm
(2" x 1" x 0.47")



▲ **MDS20**
50.8x 25.4x12mm
(2" x 1" x 0.47")

■ MDS15: 15W 单组输出

型号	输入	输出	效率
MDS15A-05	12V (9~18V)	5V, 3000mA	85%
MDS15A-12	12V (9~18V)	12V, 1250mA	88%
MDS15A-15	12V (9~18V)	15V, 1000mA	87%
MDS15A-24	12V (9~18V)	24V, 625mA	85%
MDS15B-05	24V (18~36V)	5V, 3000mA	87%
MDS15B-12	24V (18~36V)	12V, 1250mA	87%
MDS15B-15	24V (18~36V)	15V, 1000mA	86%
MDS15B-24	24V (18~36V)	24V, 625mA	87%
MDS15C-05	48V (36~75V)	5V, 3000mA	86%
MDS15C-12	48V (36~75V)	12V, 1250mA	87%
MDS15C-15	48V (36~75V)	15V, 1000mA	89%
MDS15C-24	48V (36~75V)	24V, 625mA	88%

■ MDS20: 20W 单组输出

型号	输入	输出	效率
MDS20A-05	12V (9~18V)	5V, 4000mA	86%
MDS20A-12	12V (9~18V)	12V, 1670mA	89%
MDS20A-15	12V (9~18V)	15V, 1333mA	88%
MDS20A-24	12V (9~18V)	24V, 833mA	88%
MDS20B-05	24V (18~36V)	5V, 4000mA	86%
MDS20B-12	24V (18~36V)	12V, 1670mA	88%
MDS20B-15	24V (18~36V)	15V, 1333mA	88%
MDS20B-24	24V (18~36V)	24V, 833mA	89%
MDS20C-05	48V (36~75V)	5V, 4000mA	86%
MDS20C-12	48V (36~75V)	12V, 1670mA	89%
MDS20C-15	48V (36~75V)	15V, 1333mA	88%
MDS20C-24	48V (36~75V)	24V, 833mA	90%

MDS15/20

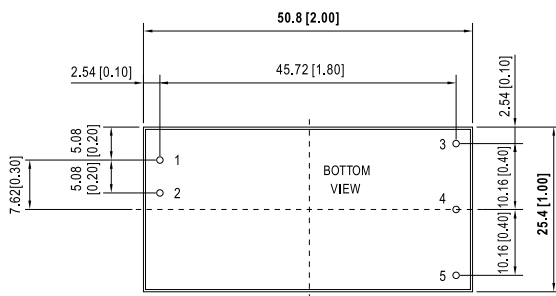

Unit: mm (inch)

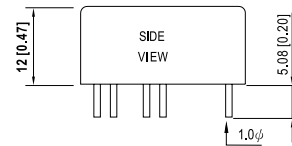

Pin No.	Pin-Out
1	+Vin
2	-Vin
3	+Vout
4	No Pin
5	- Vout

应用场景

提升系统安全



AC/DC PSU
at most 100μA



DC/DC CONVERTER
5μA max.



选型指南











AC/DC

适配器

类型	图片	机型	输入电压(VAC)	输出电压(VDC)	尺寸 (LxWxH) (mm)	隔离等级
可换输出接头		GEM06I	80~264	5, 6, 7.5, 9, 12, 15, 18, 24	73.9 x 39 x 48.5	
		GEM12I		5, 7.5, 9, 12, 15, 18, 24, 48		
		GEM18I		5, 9, 12, 15, 18, 24, 48	75.5 x 39.1 x 56.2	
		GEM30I		5, 7.5, 9, 12, 15, 18, 24, 48		
		GEM40I		5, 9, 12, 15, 18, 24, 48		
		GEM60I		5, 7.5, 9, 12, 15, 18, 24, 48		
插墙式		GSM06U/E	80~264	5, 6, 7.5, 9, 12, 15, 18, 24	66 x 32 x 42.5	
		GSM12U/E		5, 7.5, 9, 12, 15, 18, 24, 48	62.2 x 27.4 x 45.5	
	GSM18U/E	79 x 54 x 33				
	GSM25U/E	75.5 x 32 x 47.5				
	GSM36U/E					
	GSM60U/E					
桌上型		GSM18B	80~264	5, 7.5, 9, 12, 15, 18, 24, 48	79 x 54 x 33	A Type:  B Type: 
		GSM25B			125 x 50 x 31.5	
		GSM36B				
		GSM40A/B		12, 15, 19, 24, 48	145 x 60 x 32	
		GSM60A/B			167 x 67 x 35	
		GSM90A/B		12, 15, 20, 24, 48	175 x 72 x 35	
		GSM120A/B			210 x 85 x 46	
		GSM160A/B				
		GSM220A/B				

AC/DC

基板型

尺寸 (inch)	图片	机型	额定功率 (W)		输入电压 (VAC)	输出电压 (VDC)	尺寸 (LxWxH) (mm)	隔离等级	
			风扇	无风扇					
3" x 2"		RPS-30	-	30	80~264	3.3, 5, 7.5, 12, 15, 24, 48	76.2 x 50.8 x 24		
		RPS-45	-	45					
		RPS-65	-	65					
		RPS-120S	-	120					
4" x 2"		RPS-60	-	60	90~264	3.3, 5, 12, 15, 24, 48	101.6 x 50.8 x 29		
		RPD-60				5 / 12, 5 / 24			
		RPT-60				3.3, ±5, ±12, ±15, 24			
		RPS-120	120	84	80~264	12, 15, 24, 27, 48			 
		RPS-200	200	140					
5" x 3"		RPS-75	100	75	90~264	3.3, 5, 12, 15, 24, 36, 48	127 x 76.2 x 31		
		RPD-75				5 / 12, 5 / 24			
		RPT-75				3.3, ±5, ±12, ±15, 24			
		RPS-160	160	110	80~264	12, 15, 18, 24, 27, 36, 48	127 x 76.2 x 34.6		
		RPT-160	150	100					
		RPS-300	300	200	80~264	12, 15, 18, 24, 27, 36, 48	127 x 76.2 x 35		
		RPS-400	400	250					
RPS-500	500	320							
7" x 4.2"		MPQ-200	-	200	90~264	±5, ±12, ±15, 24	177.8 x 107.2 x 35.5		

AC/DC

板上型

图片	机型	额定功率 (W)		输入电压 (VAC)	输出电压 (VDC)	尺寸 (LxWxH) (mm)	隔离等级
		额定功率	峰值功率 (10 秒)				
	MFM-05	5	5.5W	80~264	3.3, 5, 12, 15, 24	42 x 22.3 x 20.5	
	MFM-10	10	11W			49 x 23.8 x 23	
	MFM-15	15	16.5W			65.5 x 35 x 23	
	MFM-20	20	23.8W				
	MFM-30	30	35W				
	MPM-05	5	5.5W	80~264	3.3, 5, 12, 15, 24	45.7 x 25.4 x 21.5	
	MPM-10	10	11W			52.4 x 27.2 x 24	
	MPM-15	15	16.5W			87x 52x 29.5	
	MPM-20	20	23.8W				
	MPM-30	30	35W				
	MPM-45	45	50.4W				
	MPM-65	65	71.5W		5, 12, 15, 24, 48		
	MPM-90	90	99.2W		12, 15, 24, 48		
	MPM-30-xST	30	35W	80~264	3.3, 5, 12, 15, 24, 48	91 x 39.5 x 28.5	
	MPM-45-xST	45	50.4W		5, 12, 15, 24, 48	109 x 52 x 33.5	
	MPM-65-xST	65	71.5W		12, 15, 24, 48		
	MPM-90-xST	90	99.2W				

AC/DC

机壳型

图片	机型	额定功率 (W)		输入电压 (VAC)	输出电压 (VDC)	尺寸 (LxWxH) (mm)	隔离等级
		风扇	无风扇				
	NMP650	650	-	90~264	5, 12, 24, 48	250 x 89 x 41	
	NMP1K2	1200	-			250 x 127 x 41	
	RPS-120-x-C	120	90	80~264	12, 15, 24, 27, 48	103.4 x 62 x 40	
	RPS-200-x-C	200	140	90~264		130 x 86 x 43	
	RPS-300-x-C	300	200		80~264	12, 15, 18, 24, 27, 36, 48	
	RPS-400-x-C	400	250	130 x 86 x 66.5			
	RPS-400-x-TF	400	-	160 x 86 x 43			
	RPS-400-x-SF	400	-	130 x 86x 43			
	RPS-500-x-C	500	320	130 x 86 x 66.5			
	RPS-500-x-TF	500	-	160 x 86 x 43			
	MSP-100	-	100	85~264	3.3, 5, 7.5, 12, 15, 24, 36, 48	159 x 97 x 38	
	MSP-200	-	200			199 x 98 x 38	
	MSP-300	300	-			199 x 105 x 41	
	MSP-450	450	-			218 x 105 x 41	
	MSP-600	600	-			218 x 105 x 63.5	
	MSP-1000	1000	-				

DC/DC

转换器

图片	机型	额定功率 (W)	输入电压 (VDC)	输出电压 (VDC)	尺寸 (LxWxH) (mm)
	MDS01	1	L: 4.5 ~ 5.5 M: 10.8 ~ 13.2 N: 21.6 ~ 26.4	3.3, 5, 12, 15	19.5 x 9.8 x 12.5 (0.77" x 0.39" x 0.49")
	MDS02	2		5, 12, 15	
	MDD01	1		±5, ±9, ±12, ±15	
	MDD02	2			
	MDS15	15	A: 9 ~ 18 B: 18 ~ 36 C: 36 ~ 75	5, 12, 15, 24	50.8 x 25.4 x 12 (2" x 1" x 0.47")
	MDS20	20			

媒体工具



MEAN WELL E-news

在MEAN WELL网站的左下角找到“订阅电子报”。填写电子新闻订阅表，最后点击“订阅”。收到您的信息后，我们将发送电子邮件给您确认。



MEAN WELL NEWS APP



安装 MEAN WELL NEWS APP，随时查看明纬最新资讯。



社交媒体

01

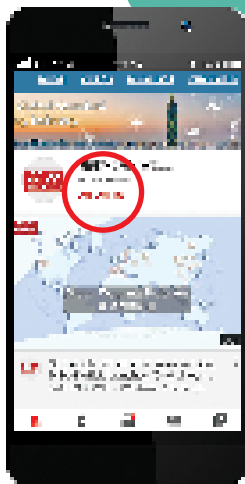

01 YouTube

- 扫描二维码
- 点击“订阅”按钮
- 开启铃铛通知，不漏接明纬的每个讯息!



02

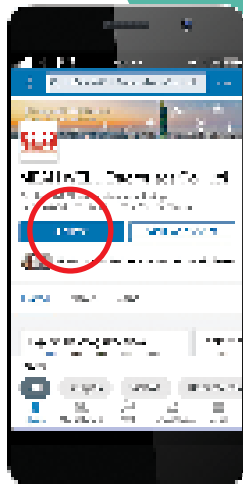

02 LinkedIn

- 扫描二维码
- 导航到MEAN WELL页面并“关注”我们。



03

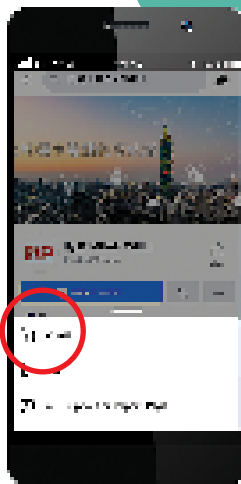

03 Facebook

- 扫描二维码
- 找到图标， 并选择“关注”
- 别忘了“like”我们哦。



04

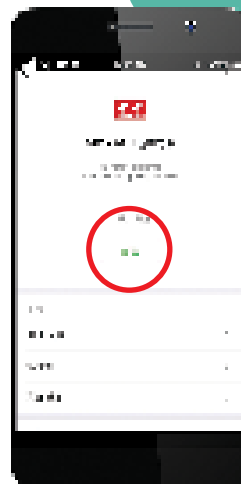

04 WeChat

- 在微信APP中搜索官方账号“MEAN WELL”
- 点击“关注”按钮



05

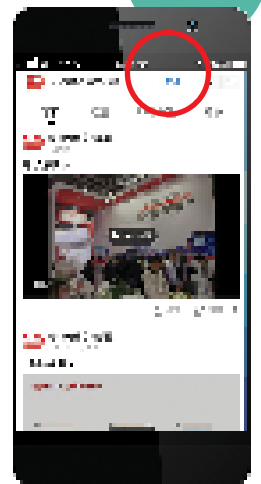

05 YouKu

- 扫描二维码
- 点击顶部“订阅”



Taiwan

明纬企业股份有限公司(总部)

24891 新北市五股区五权三路28号

Tel +886-2-2299-6100(rep.)

Fax +886-2-2299-6200(rep.) +886-2-2298-0818(sales)

e-mail info@meanwell.com

Web www.meanwell.com

U.S.A.

MEAN WELL USA, INC.

44030 Fremont Blvd., Fremont, CA 94538, U.S.A.

Tel +1-510-683-8886

Fax +1-510-683-8899

e-mail info@meanwellusa.com Web www.meanwellusa.com

Europe

MEAN WELL EUROPE B.V.

Langs de Werf 8, 1185XT Amstelveen, the Netherlands

Tel +31-20-758-6000

Fax +31-20-758-6001

e-mail info@meanwell.eu Web www.meanwell.eu



info@meanwell.com.cn
www.meanwell.com.cn



China

明纬(广州)电子有限公司

广州市花都区花东镇金谷南路11号

Tel: +86-20-3773-7100 / 400-800-3608(销售)

+86-755-2359-1630(深圳办事处)

+86-28-8546-8628(成都办事处)

e-mail: info@meanwell.com.cn Web: www.meanwell.com.cn

苏州明纬科技有限公司

苏州市相城区黄埭镇长平路269号

Tel: +86-512-6508-8600 Fax +86-512-6508-8700

+86-10-5200-1817(北京办事处)

e-mail: info@meanwell.cc Web: www.meanwell.cc

MEAN WELL(HONG KONG)HOLDING LIMITED

Unit 6, 7/F, Goldfield Industrial Center, No.1 Sui Wo Road, Fotan, Shatin, N.T., Hong Kong

Tel: +852-2643-9098

E-mail: vickiho@meanwell.com.hk

印度

MEAN WELLINDIA ELECTRONICS PRIVATE LIMITED

Plot No.9C, GF-1F, Peenya Industrial Area, 2nd Phase, Chokkasandra Main Road, Bengaluru-560058

Tel: +91-9686448906

E-mail: benaka.v@meanwellindia.com

Web:www.meanwellindia.com

